



# PORTFOLIO JAREN HUBAL

UPDATED JANUARY 2024

## CONTACT

[jaren@jarenhubal.com](mailto:jaren@jarenhubal.com)

[linkedin.com/in/jhubal](https://www.linkedin.com/in/jhubal)

## LEFT: MAZE OF MY INTERESTS

Hand-drawn, color added in Photoshop

*Personal project for senior page in high school  
yearbook, 2015*

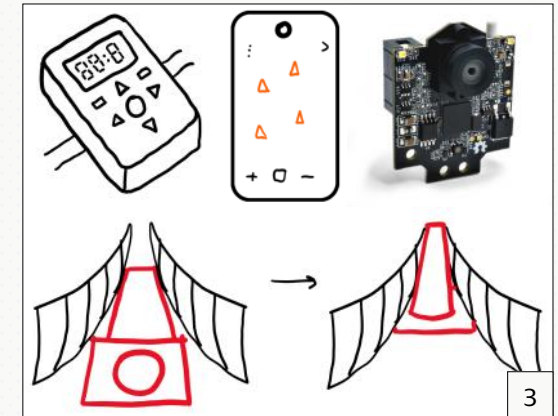
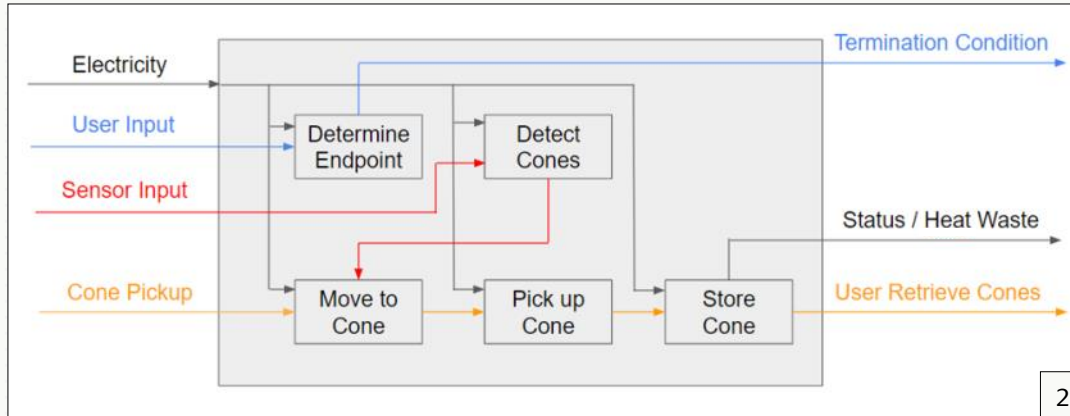
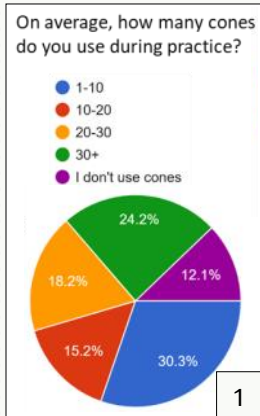

## CONEBOT AUTONOMOUS CONE COLLECTION ROBOT, PART 1: DESIGN PROCESS

1. Survey question from consumer outreach. We identified stakeholders and created target specifications for the robot based on feedback from potential customers.
2. Functional decomposition and interactions among subsystems. A teammate created this diagram.
3. Concept sketches and images for some of the subfunctions identified during functional decomposition. Full-system concepts were created by combining a concept from each subsystem. The best full-system concept was identified through screening and scoring matrices.
4. Many tests were performed to inform design, such as this one which measured how high cones stacked and therefore how much storage space was needed on the pickup arm.
5. First prototype of robot. Full-system concept was drafted using SolidWorks, and prototype was built using 3D printed, laser cut, and off-the-shelf components. Building the robot was a team effort.

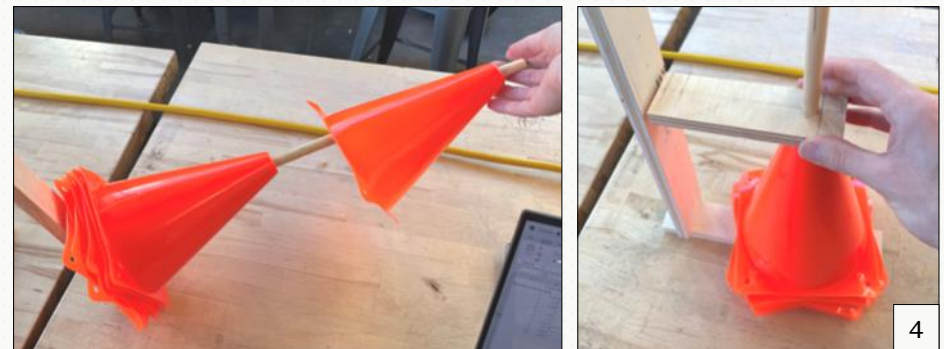

*Team project in Electromechanical Systems Design course at Carnegie Mellon University, 2023. Images shown are my creation unless otherwise stated.*





1



2

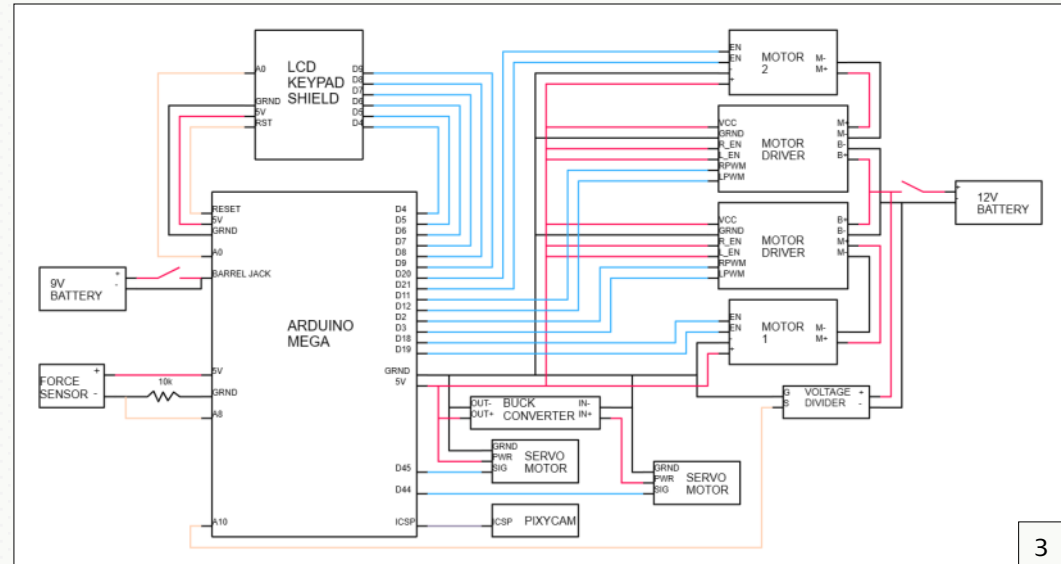

3

## CONEBOT AUTONOMOUS CONE COLLECTION ROBOT, PART 2: FINAL PROTOTYPE

1. User interface, programmed for Arduino. Buttons below screen were used for input. Inputs included number of cones for the robot to pick up, terrain, and size of collection area.
2. Force sensor mounted to the pickup arm, used to detect if a cone was successfully picked up.
3. Robot electronics schematic.
4. Final robot, built with 3D printed, laser cut, and off-the-shelf components. Building the robot was a team effort.
5. Robot picking up a cone.

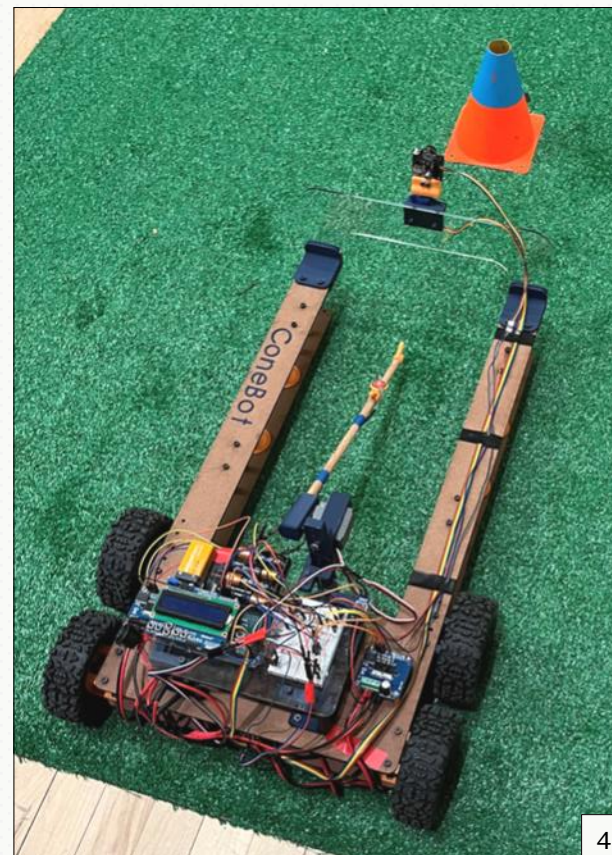

4



5



## ARTIFACT INSTALLATION FOR AIR AND SPACE MUSEUM RENOVATION

1. An artifact arriving on a truck and being unloaded with a telehandler. Most large artifacts, such as aircraft, arrive this way. My role was to coordinate delivery dates and times and assure necessary permits for wide loads and road closures had been obtained.
2. An airplane enters museum building through hangar door on west end. My role was to coordinate with site superintendents to clear a path for artifacts to travel through the active construction site.
3. An aircraft being rigged into position. My role was to verify final artifact hanging points on truss steel.
4. Gallery before artifacts were installed.
5. Gallery after all hanging artifacts were installed.

*Professional work with the Smithsonian Institution, 2021-2022.*





# SENIOR DESIGN PROJECT, PART 1: DESIGNING BUILDING FOOTPRINT AND FLOOR PLANS

1. Site plan showing buildable area, drawn in AutoCAD over existing topography map. Project used a real site in Southeast Michigan.
2. Three building footprints considered, drawn in AutoCAD.
3. Final building footprint selected along with parking areas and driveways, drawn in AutoCAD. Selecting final footprint was a team effort.
4. Floor plans for residential, office, and retail floors, drawn in Revit. Devised to meet client and code requirements as well as to maximize client's income potential. Designing floor plans was a team effort.

Team project in Professional Issues and Design course at the University of Michigan, 2020. All images shown are my creation.

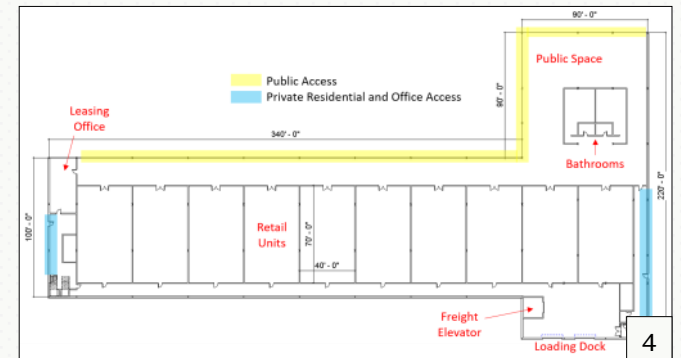
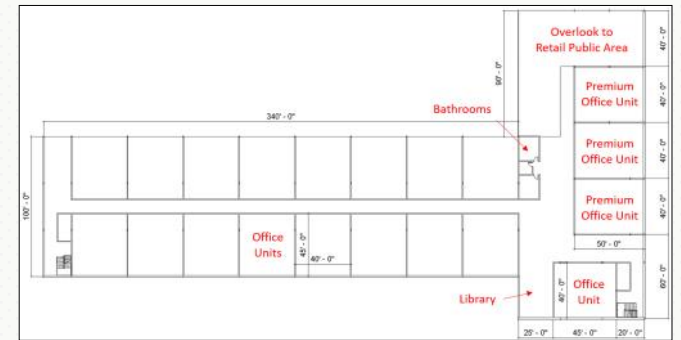
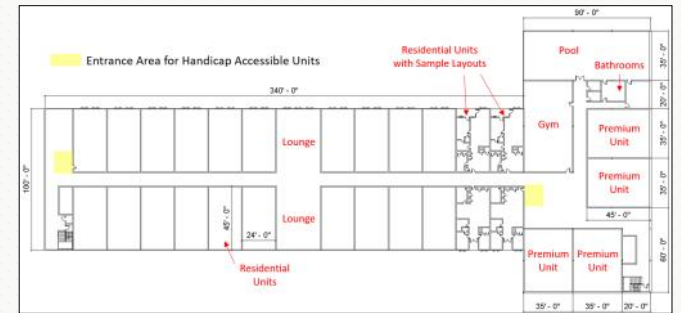
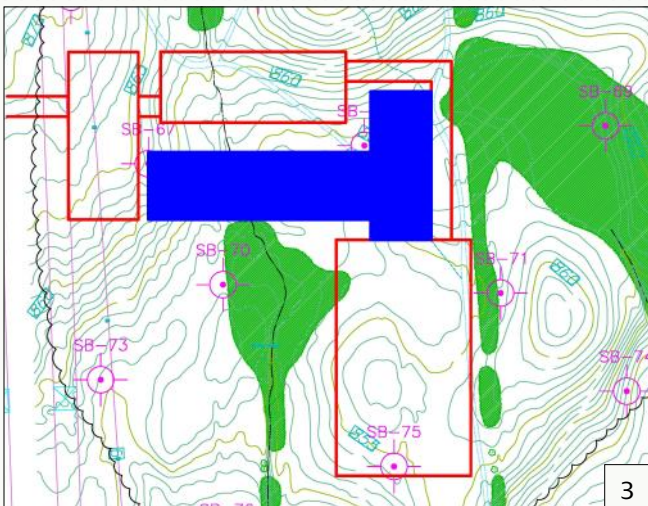
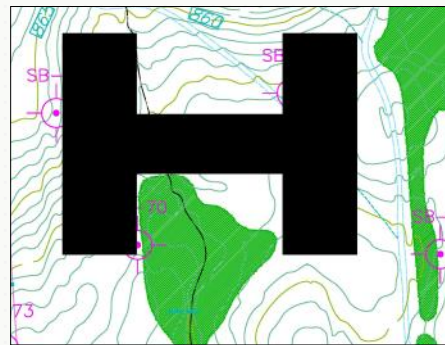
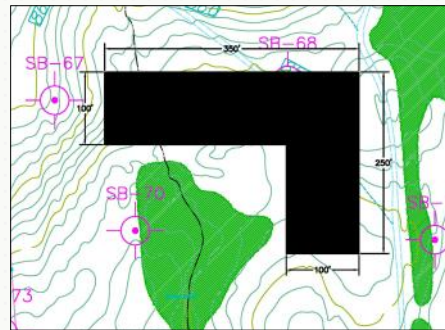
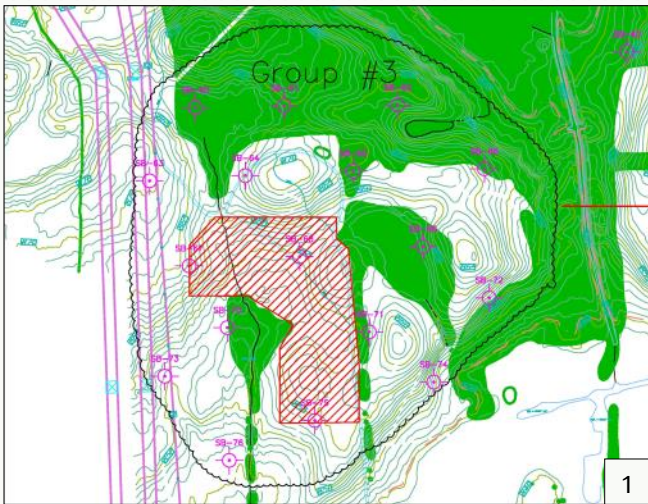

## SENIOR DESIGN PROJECT, PART 2: DESIGNING STEEL STRUCTURE

1. Steel structure modeled in Revit. West residential wing used a wood structure which was designed by a teammate.
2. Roof steel layout with each column, girder, and beam labeled based on size. Steel was sized using the AISC Steel Construction Manual. Same process was used for all building levels.
3. Front view of building modeled in Revit. Final design was presented as a team to a panel of professional engineers and submitted in a report to professors.

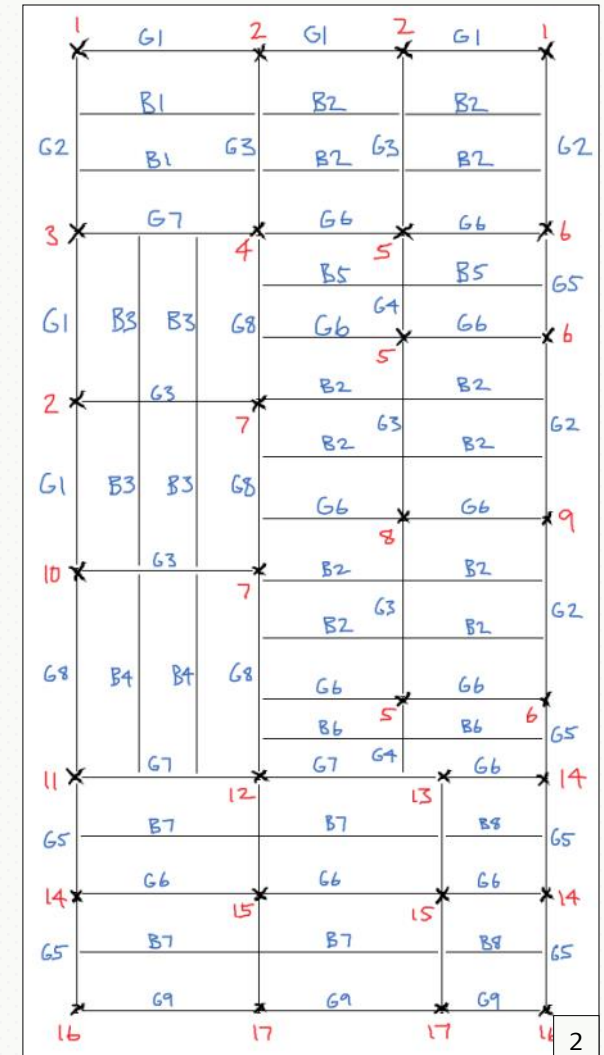
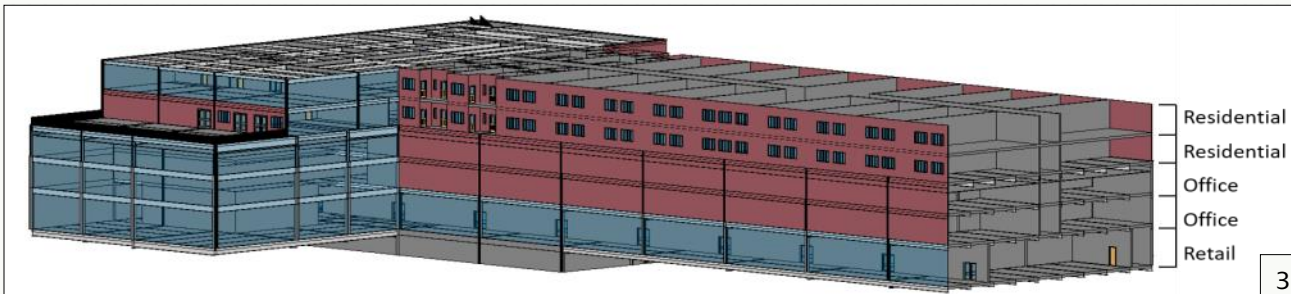
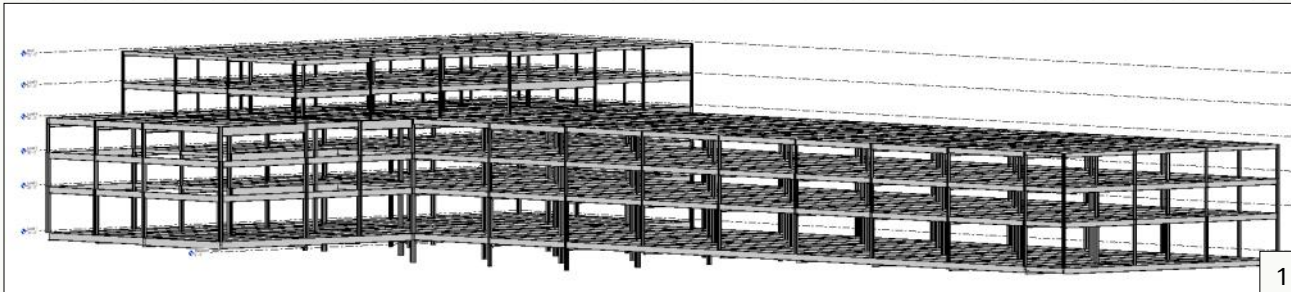



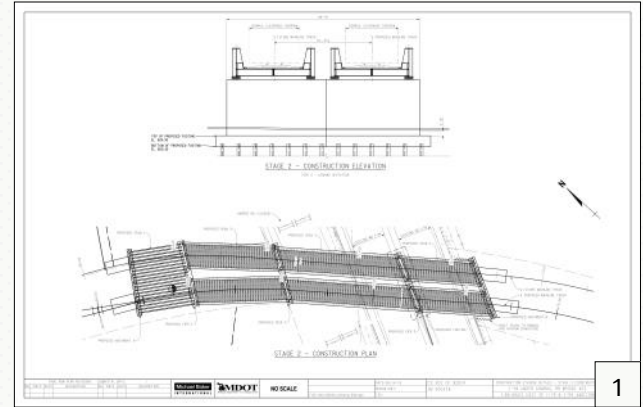
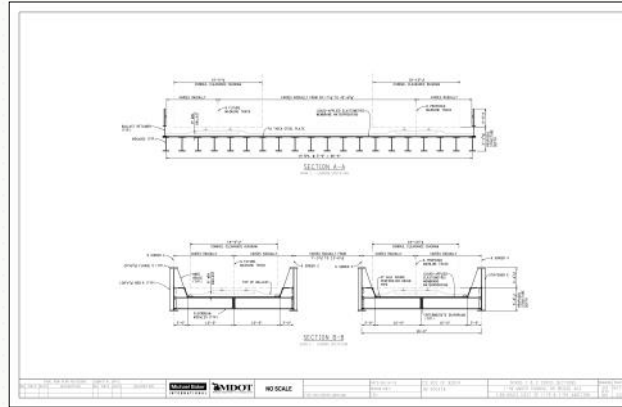
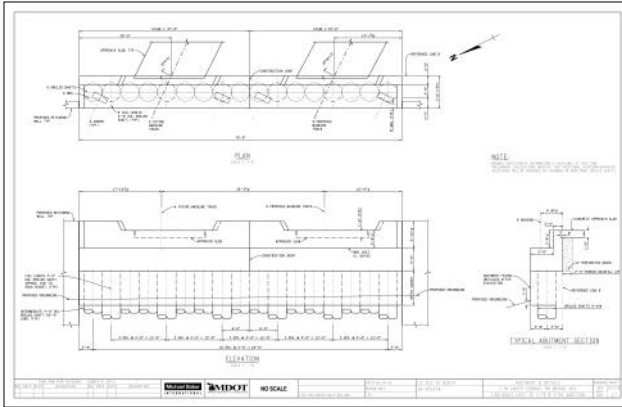

## BRIDGE RECONSTRUCTION PROJECTS

1. Type, size, and location (TS&L) drawings, created in MicroStation, to show foundation system, bridge structure, and construction staging. My role was to calculate bearing seat elevations, draft the bridge design, and make final layouts.
2. Drainage configurations created in AutoCAD based on TS&L drawings. My role was to map drainage areas and draft drainage plans.
3. Public outreach maps to communicate impacts of bridge construction project.

Professional work as civil engineering intern at Michael Baker International, 2019.

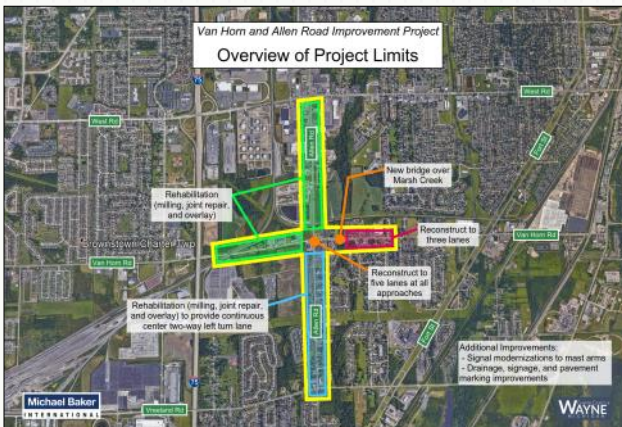
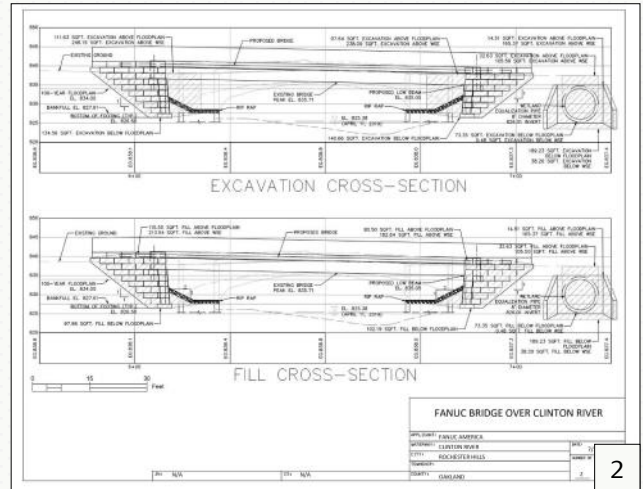

## TRANSPORTATION PLANNING MAPS

1. Traffic trends in Raleigh over past 20 years, mapped in ArcGIS using annual average daily traffic data. Larger red dots show larger increases and larger blue dots show larger decreases in traffic.
2. Traffic changes along one main corridor demonstrating that a road diet project successfully reduced traffic. This map is useful for identifying other roads that similarly require attention.
3. Limits of traffic studies performed throughout the city, mapped in ArcGIS. This map helps to locate previously performed studies for use in development reviews.
4. Example of data fields populated for each traffic study, including date of study and a link to the study itself.

*Professional projects as transportation planning intern at the Raleigh Department of Transportation, 2018.*

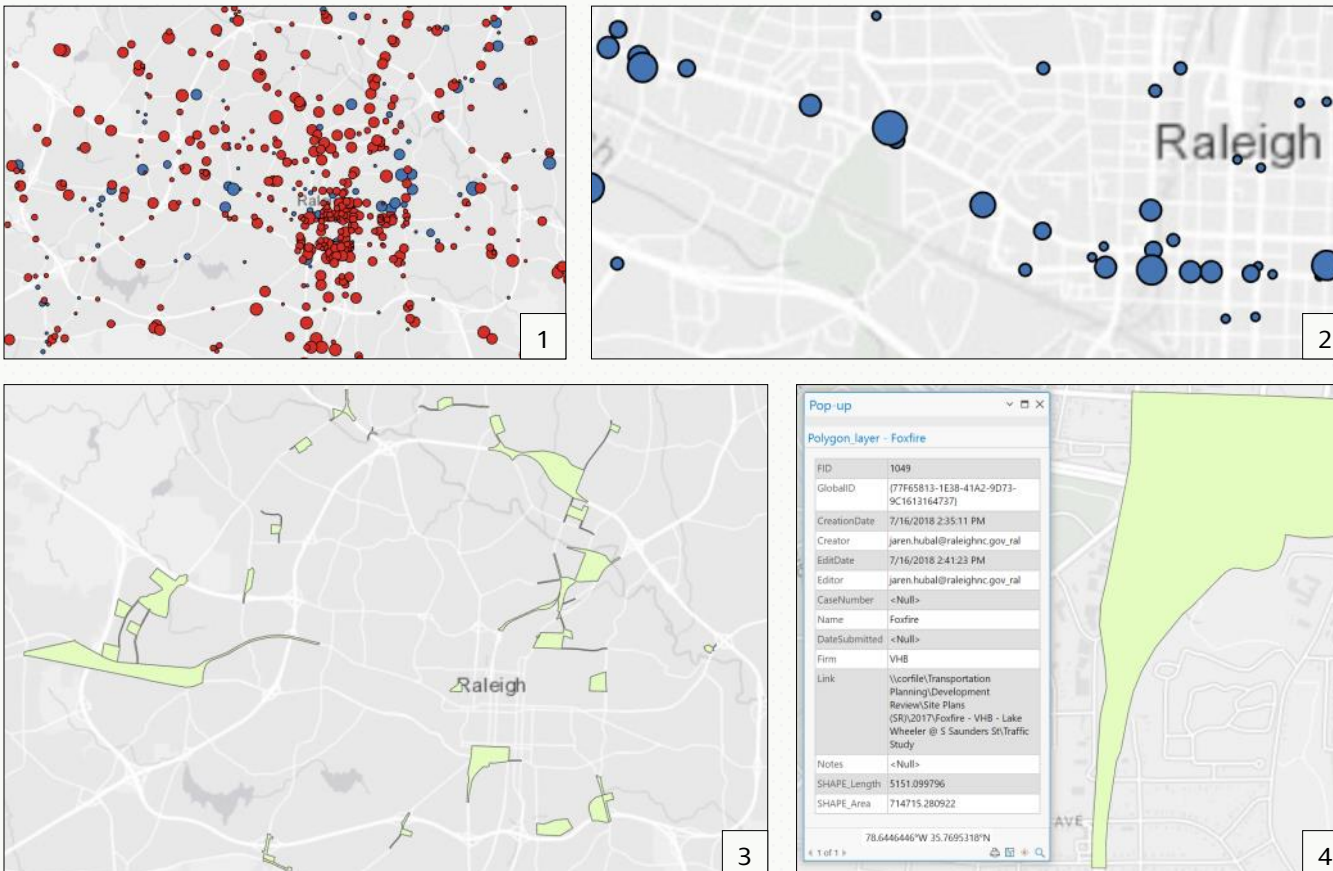



## DIGITAL COLLAGE, PART 1: CREATING DECORATIVE OBJECTS

1. Patterns created using various hand-drawing, Illustrator, and Photoshop techniques.
2. Surfaces before and after patterns were applied in Photoshop. Patterns were also applied to the carpet and the woman's sweater, shown in final collage on next page.
3. Before and after images stylized in Illustrator and Photoshop and used as paintings in final collage.
4. A sampling of stock images used to create cutouts in Photoshop.

*Individual project for Studio 2D course at the University of Michigan, 2019.*

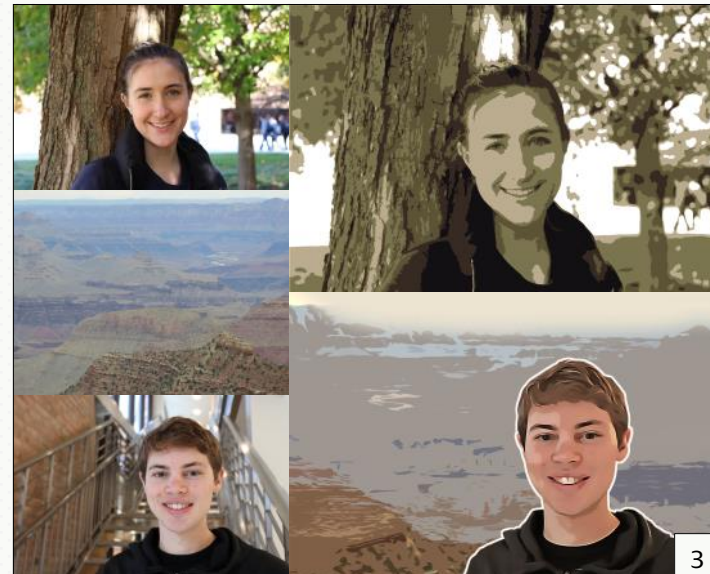



## DIGITAL COLLAGE, PART 2: ASSEMBLING FINAL COLLAGE

1. Raw images captured around campus that were used as basis of collage. Collaborated with classmates to obtain human subjects.
2. Final collage, with raw images combined in Photoshop and edited to add enhanced sunlight effect, sketched wall and ceiling detail, and decorative objects. Printed on 11x17" paper. Goal was to join all elements into a unified indoor and outdoor space.





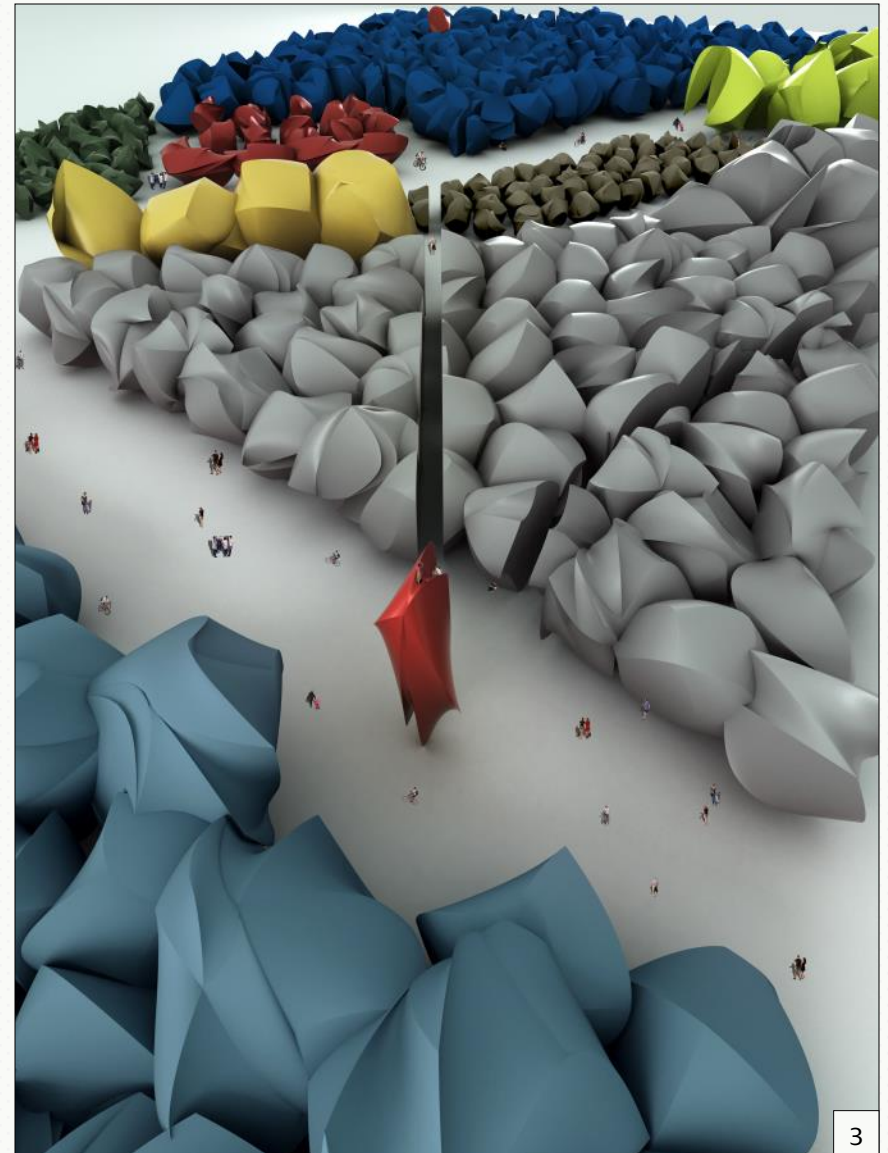
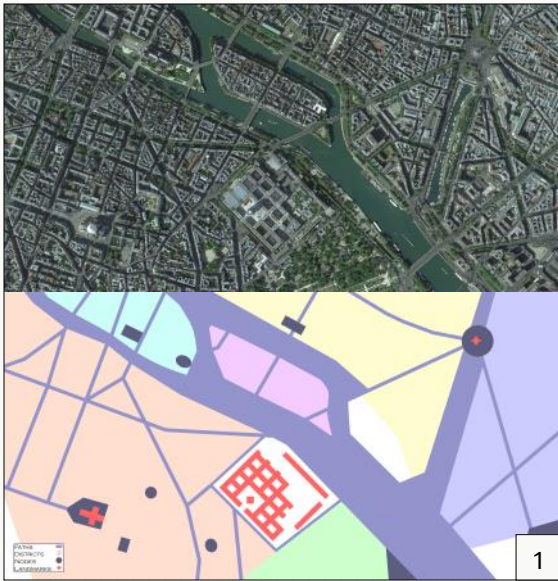

## AERIAL CITY RENDERING

1. Imagined city plan highlighting important paths, districts, nodes, and landmarks. Abstracted in Illustrator from an aerial photograph of Paris, France.
2. Abstract objects created in Rhinoceros to practice 3D manipulation techniques and formatted for display in Illustrator.
3. Aerial view of imagined city created by arranging the objects according to the city plan. Assembled in Rhino, rendered with V-Ray, altered in Illustrator and Photoshop, and printed on 18x24" paper. Final rendering is of view from top right toward bottom left of city plan.

*Individual project for Digital Drawing studio course at the University of Michigan, 2016.*

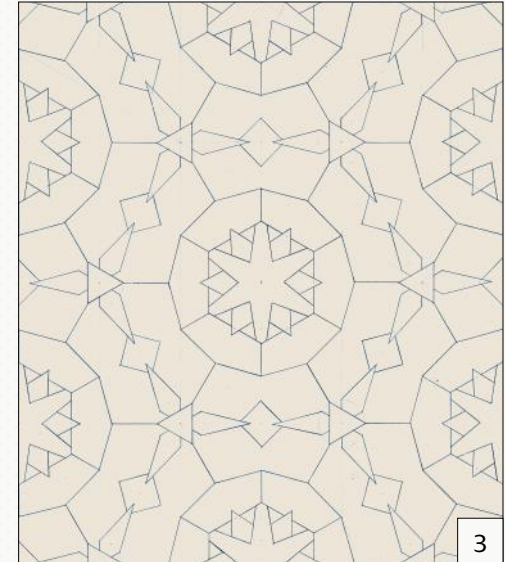
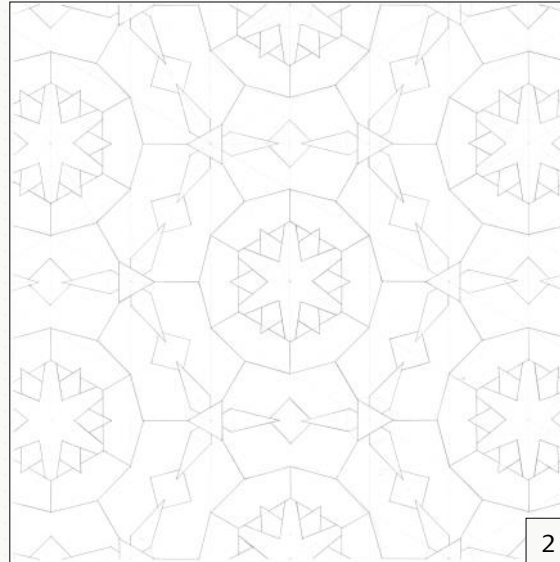
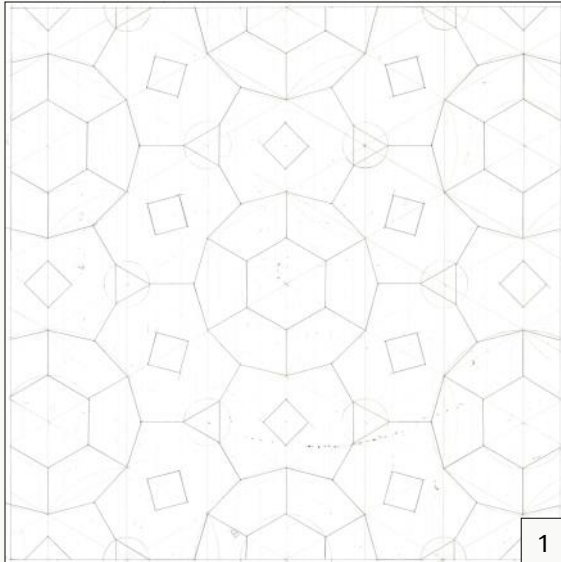

## TESSELLATION WALLPAPER

1. First draft pattern, hand-drawn.
2. Final pattern, hand-drawn.

*Graphic Communication studio course at the University of Michigan, 2018.*

3. Final pattern with color added in Photoshop, cropped to extents of repeatable pattern. Wall paint RGB values used for background color.
4. Final printed wallpaper applied to wall under a kitchen island. If recreating I would work with the printing company to improve the color match.

*Personal project, 2020.*

